

# PLASMA-THAWING-MACHINE

**THE RAPID THAWING SYSTEM FOR CRYOPRESERVED BLOOD PLASMA (FRESH FROZEN PLASMA)**

- DRASTICALLY REDUCES THE THAWING TIME AND**
- MEETS ALL MODERN IT-REQUIREMENTS OF THE HOSPITAL.**

Cologne, January 2025

Leven GmbH, Frankenstraße 29, 50858 Cologne, Germany

+49 172 7115206 – [wleven@blutplasma-auftauen.de](mailto:wleven@blutplasma-auftauen.de)

Prof. Dr. Wilfried Leven



## BLOOD PLASMA

- / In case of emergency
- / In transplants
- / In surgery
- / In therapy

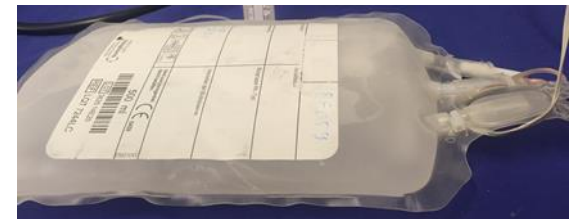

Plasma bag 300ml

# CONTENTS

- / The unique product benefit (USP)
- / The sales area, the distribution
- / The competitors
- / The customers
- / The market volume
- / The business case
- / The value of the patent
- / The acting people
- / Why invest?

# THE UNIQUE PRODUCT BENEFIT (USP)

## PLASMA-THAWING-MACHINE

# THE USP

- ✓ DEFROSTS GENTLY IN 8 MINUTES (QUALITY OF PLASMA MAINTAINED)
- ✓ CAN BE FULLY INTEGRATED INTO THE IT-SYSTEM (LAN, WLAN)
- ✓ IS PART OF THE BLOOD PLASMA SUPPLY CHAIN (QR CODE, RFID, USER IDENTIFICATION)
- ✓ SAVES ALL IMPORTANT USAGE DATA
- ✓ OFFERS REMOTE MAINTENANCE VIA WWW
- ✓ IS INTUITIVE TO USE
- ✓ **THE USERS OF MED. DEFROSTING DEVICES ARE WAITING FOR SUCH A DEVICE**

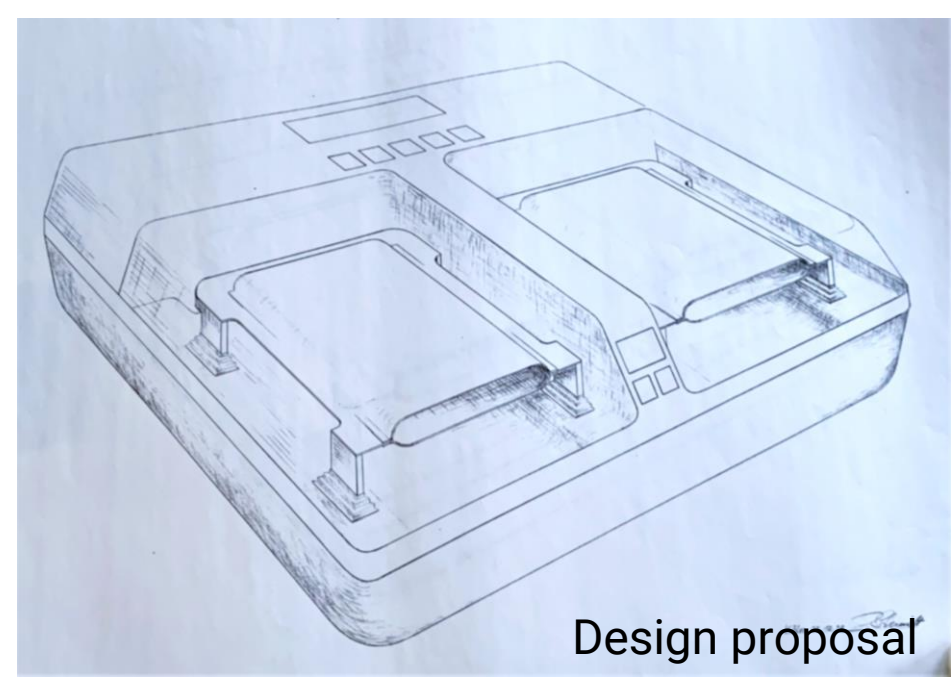

Design proposal

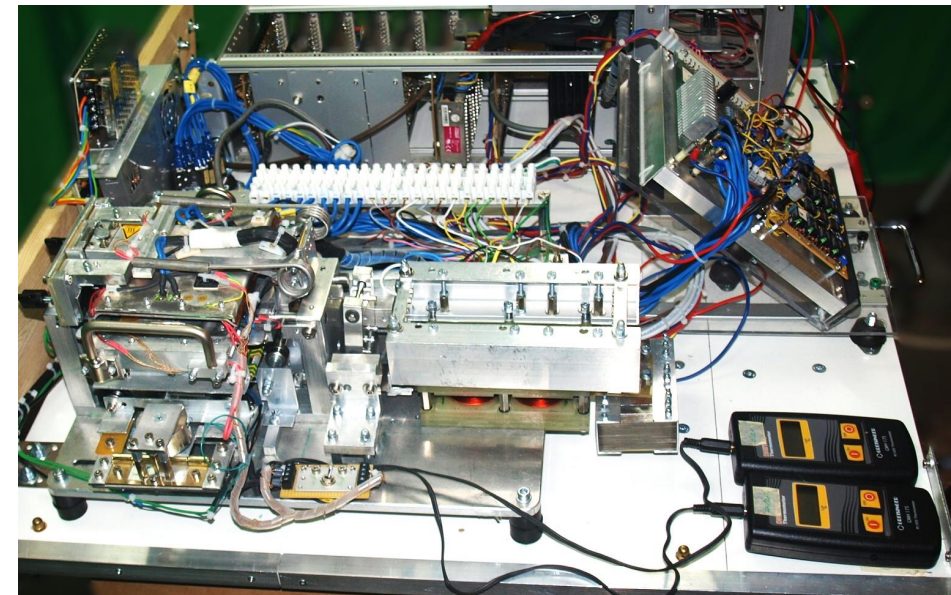

functional model

## The functional model 2.0

warming  
compartment  
for plasma bags  
300 ml →

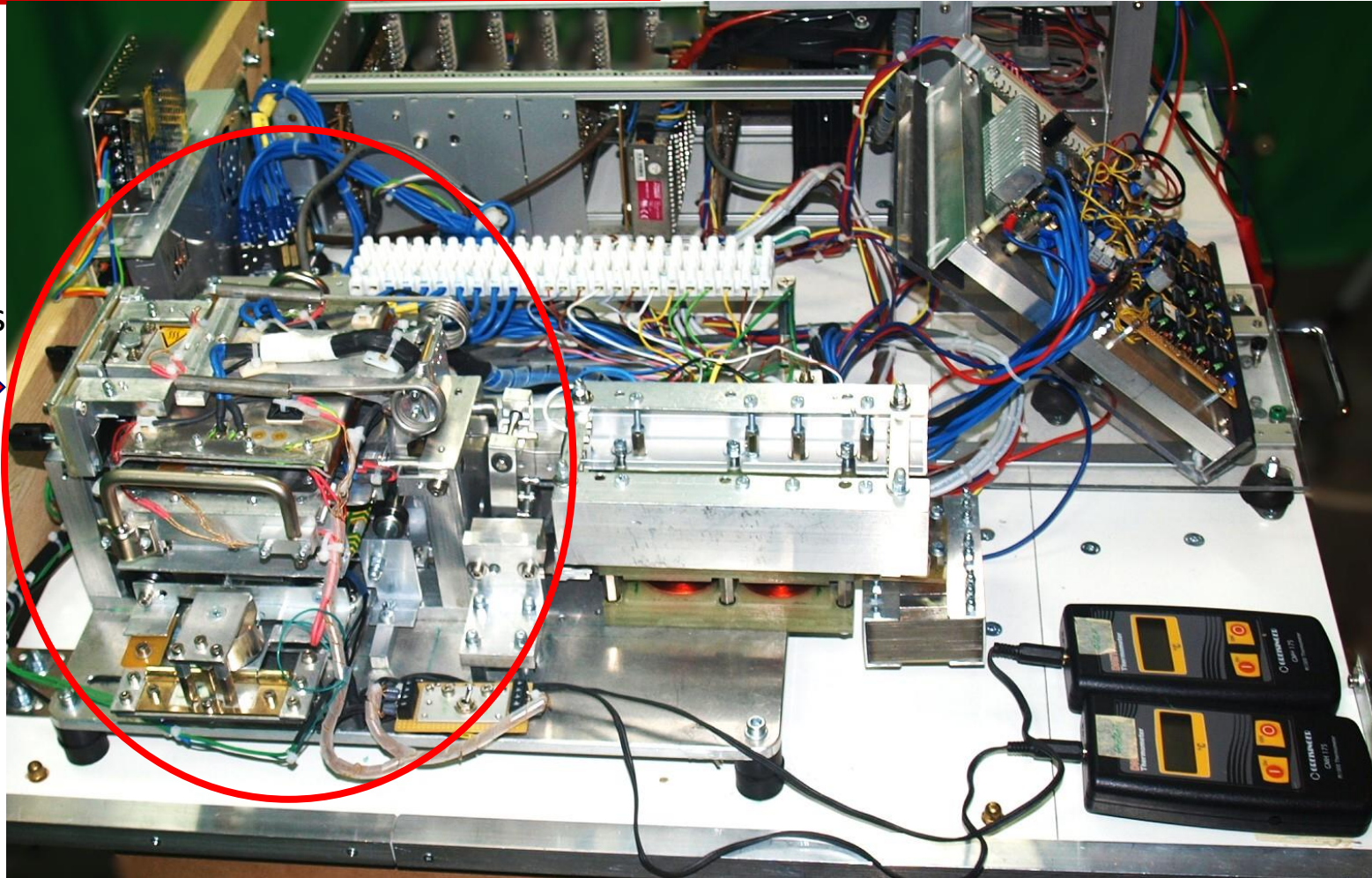

### What accelerates the defrosting process?

- In the warming compartment: 42 degrees Celsius are always present
- at the same time: the bag is moved back and forth to mix the content of the bag
- As soon as the content of the bag become plastic, the back will be shaken in a special way

the bag is moved back and forth to mix the content of the bag

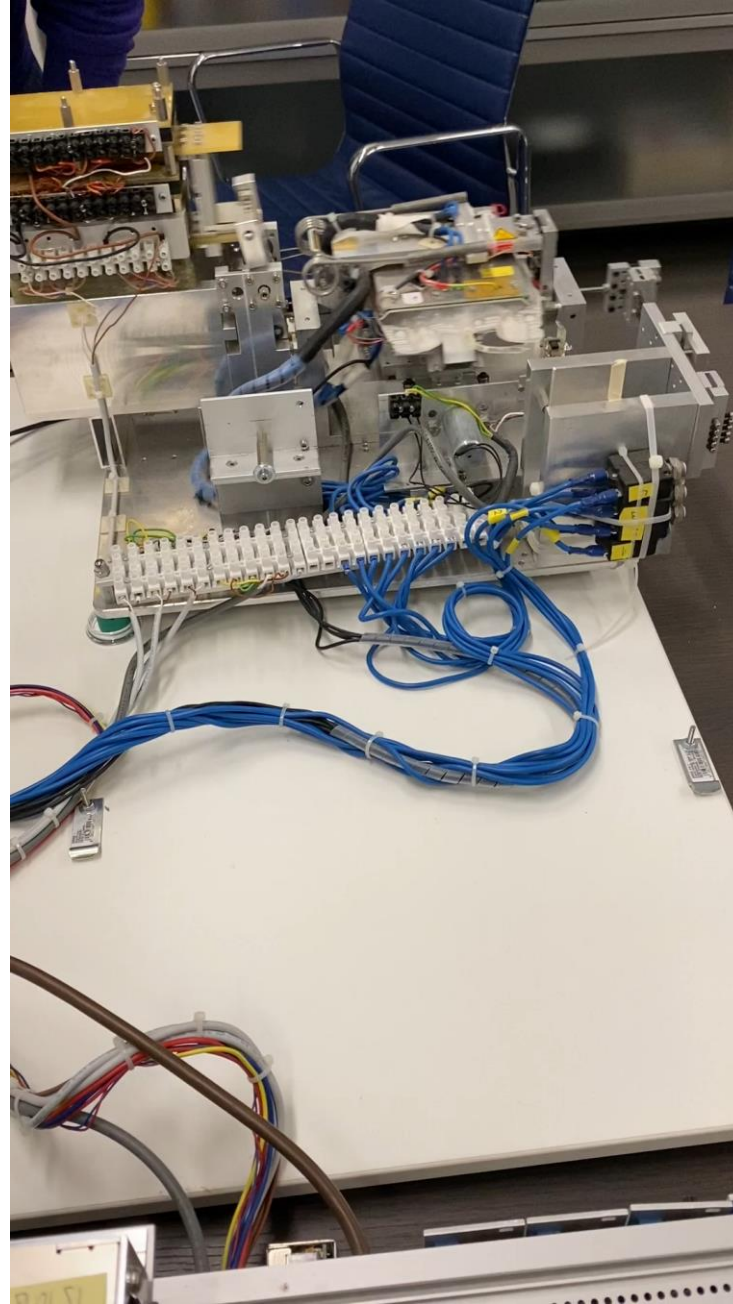

Bag compartment in motion:  
1. Back and forth  
2. Shaken

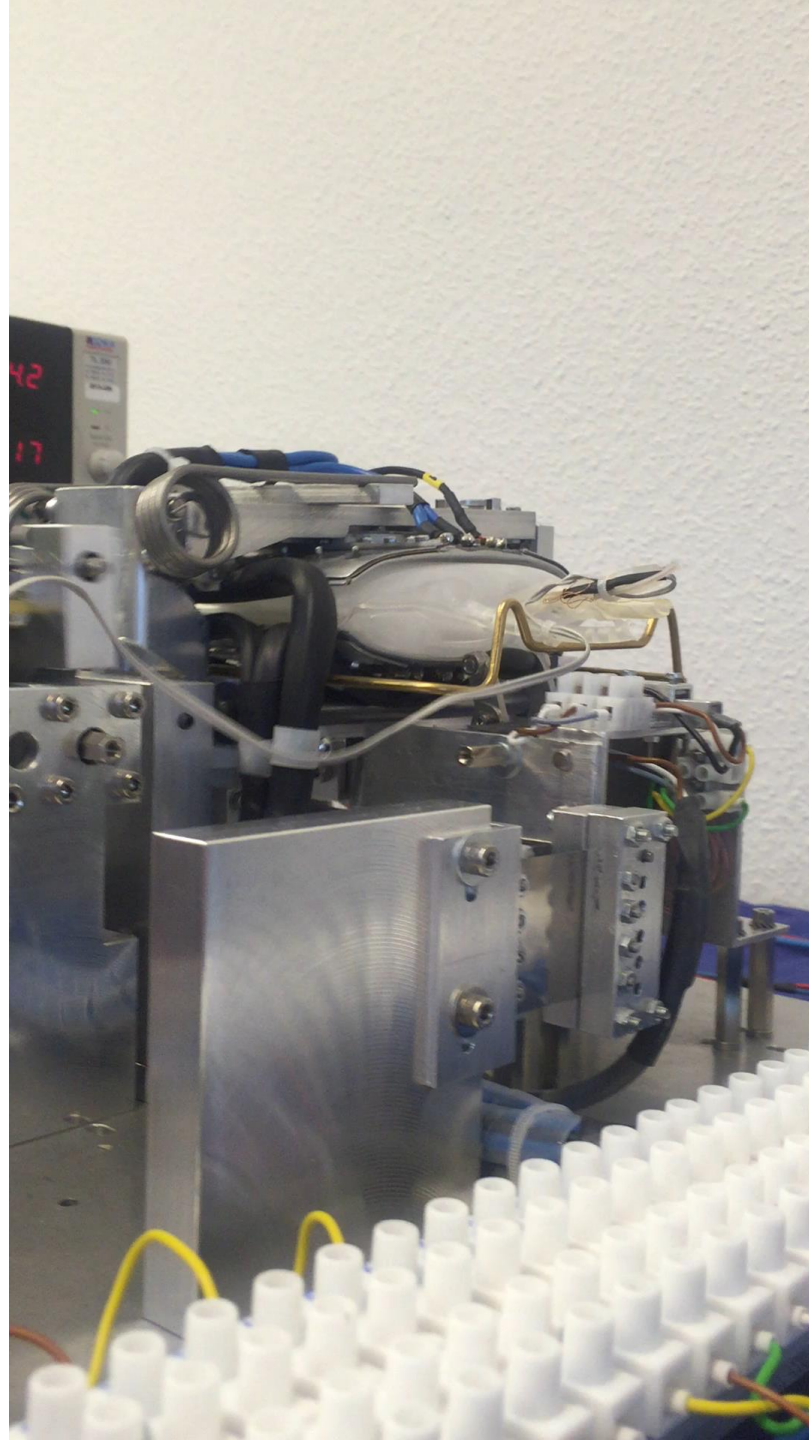

# ONLY APPROVED MEDICAL DEVICES ALLOWED IN EU

THE CURRENT POLICY:

"ALL (...FOR THAWING...) USED INSTRUMENTS,  
APPARATUS AND DEVICES MUST COMPLY WITH THE  
REGULATIONS OF THE MPG (MEDICAL DEVICES ACT)."

HERE: CLASS I MEDICAL DEVICES (EU)

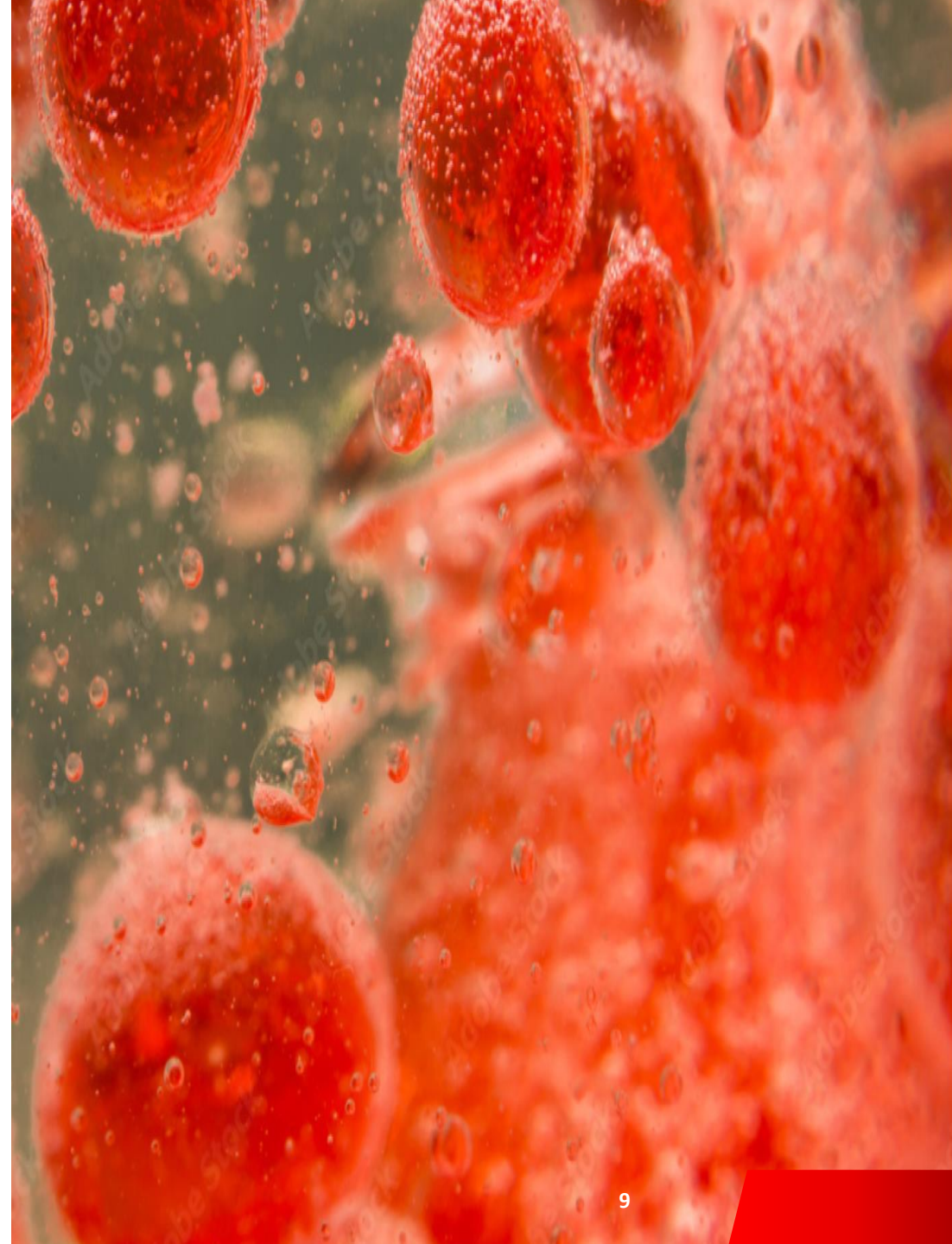

# EU PATENT GRANTED ON 29/11/2023

/ ***Thawing device for thawing a substrate and method for thawing a substrate***

/ ***Application number: EP21157125.2***

/ ***Publication number: EP3995162***

/ ***Patent applied for: USA, China, India***

- **UTILITY MODEL: DE2020106563U1 ISSUED ON MARCH 4TH, 2021**

## - Online Patent Information and Document Inspection Service

EP3995162 - Thawing device for thawing a substrate and method for thawing a substrate

### Case Details

Application Number	EP21157125.2
Application Source	European
Application Language	German
Publication Number	EP3995162
Publication Language	German
Status	Granted
Filing Date	15 February 2021
Publication Date	11 May 2022
EPO Grant Date	29 November 2023
Grant Date	Patent granted with effect from 29 November 2023 (Section 25(1))
Next Renewal Date	15 February 2025
Priority Claimed	06 November 2020 in Germany - Document: 102020129292
Designated States	AL AT BE BG CH CY CZ DE DK EE ES FI FR GB GR HR HU IE IS IT LI LT LU LV MC MK MT NL NO PL PT RO RS SE SI SK SM TR
Application Title	Thawing device for thawing a substrate and method for thawing a substrate
Grant Title	Thawing device for thawing a substrate and method for thawing a substrate
Address for Service	IP21 LIMITED Suite 2, The Old Dairy Elm Farm Business Park Wymondham Norwich NR18 0SW United Kingdom [ADP Number 13230354001]
Applicants / Proprietors	GÜNTHER SCHMIDT Martin-Legros-Straße 79 53123 Bonn Germany [ADP Number 50078048001]  AGENTUR LEVEN GMBH Frankenstraße 29 50858 Köln Germany [ADP Number 50078055001]
Inventor	GÜNTHER SCHMIDT 53123 Bonn Germany [ADP Number 50078063001]
EPO Representative	HOHENDORF KIERDORF PATENTANWÄLTE PARTGMBB Hohenzollernring 79-83 (Capitol) 50672 Köln Germany [ADP Number 95177713001]

**PLASMA-THAWING-MACHINE** can be used for many  
**cryoconservations**

**Stem cells and ova,  
sperm cells,  
erythrocyte concentrates (red blood cells),  
tissues,  
infusion solutions,  
embryos  
fibrin glue  
or even  
food**

# THE SALES AREA

# THE SALES AREA, THE DISTRIBUTION

**Worldwide**

**Growth markets:**

**Asia**

**Central and South America**

**Africa**



# THE COMPETITORS

# THE COMPETITORS

- **ONLY 15 MANUFACTURERS WORLDWIDE**
- **THE PREVIOUS THAWING MECHANISMS:**
  - WARM WATER
    - NEEDS TO BE SERVICED ONCE A YEAR
  - WARM AIR
    - NOT A PARTICULARLY GOOD MEDIUM
  - MICROWAVE
    - DIFFICULT TO OPERATE
- **MARKET PRICES OF THE COMPETITORS BETWEEN € 7,000 AND € 14,000 (IN GERMANY)**



# THE CUSTOMERS

# THE CUSTOMERS

- **HOSPITALS**
  - EMERGENCY DEPARTMENTS
  - ANESTHESIA
  - SURGICAL AREAS
  - TRANSPLANTS
  - BLOOD BANKS
  - TRANSFUSION MEDICINE
  - ONCOLOGY CLINICS
- **ONCOLOGY MEDICAL PRACTICES**



Hospitals have entire batteries of defrosting devices

Even if only one bag is defrosted, a medical defrosting device is required

# THE MARKET VOLUME

# PLASMA-THAWING-MACHINE MARKET VOLUME /YEAR

## • MARKET RESEARCH FINDINGS BY REPORTLINKER DEC 2020

- MARKET SIZE MED. THAW SYSTEMS: US\$ 243.7 MILLION (EUROPE, US, ASIA)
- MARKET GROWTH: 10.4% CAGR (COMPOUND ANNUAL GROWTH RATE)
- CA. 40% PLASMA DEVICES
- AVERAGE PRICE: € 8,000

## • VALIDATION BASED ON:

- HOSPITAL BEDS
- POPULATION FIGURES
- INTERVIEWS WITH ANESTHESIOLOGISTS
- ESTIMATIONS OF COMPETITORS

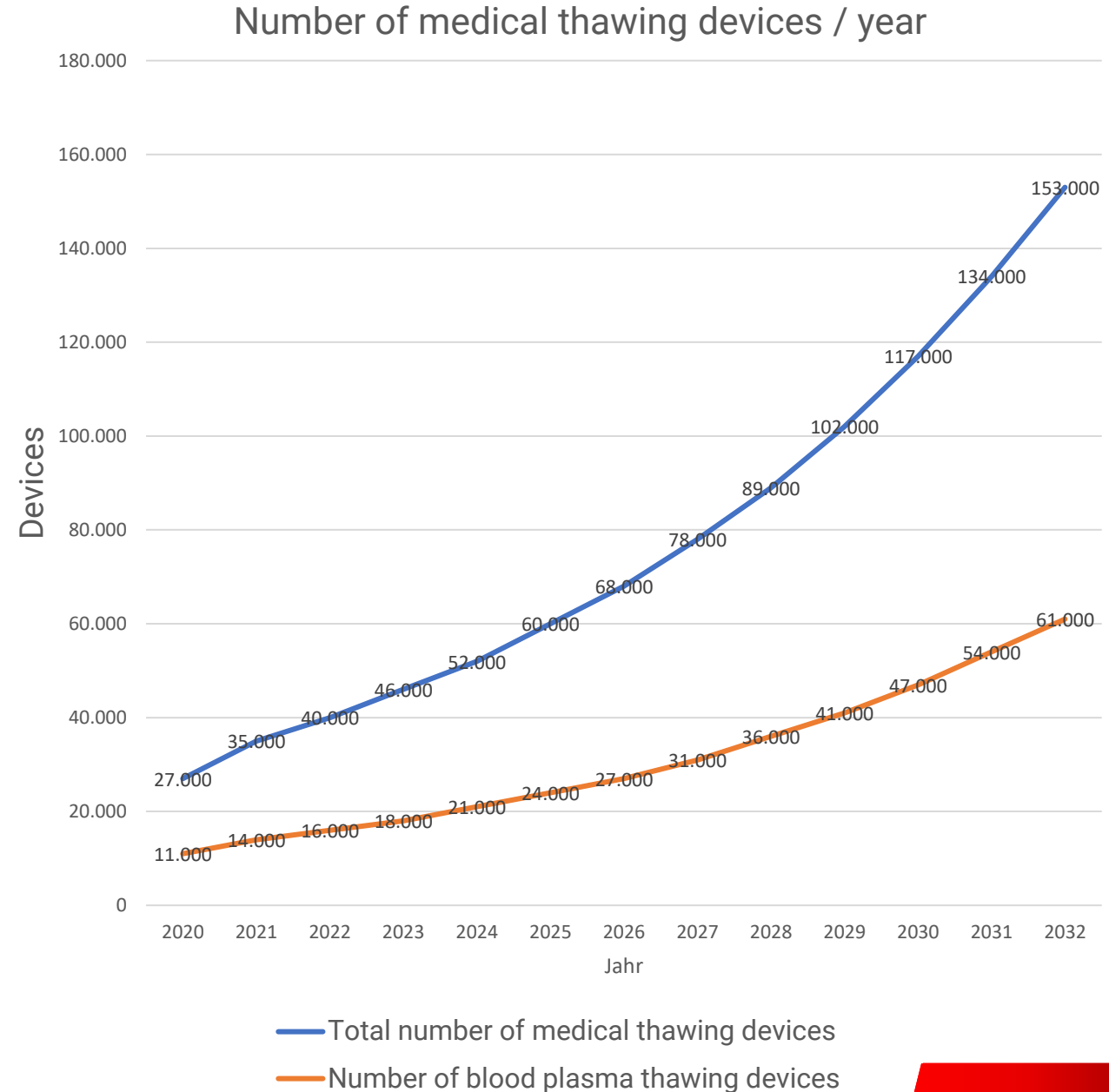

# THE BUSINESS CASE

## TURNOVER PLASMA-THAWING-MACHINE

- Market share Plasma-Thawing-Machine
  - BETWEEN 4 % (2024) AND 25 % (2032)
  - DEPENDING ON THE SALES AREA AND PRICE LEVEL
  - AS THE PRICE INCREASES; THE MARKET SHARE DECREASES

## Turnover (Million €) vs. Price - Total Market (without Africa)

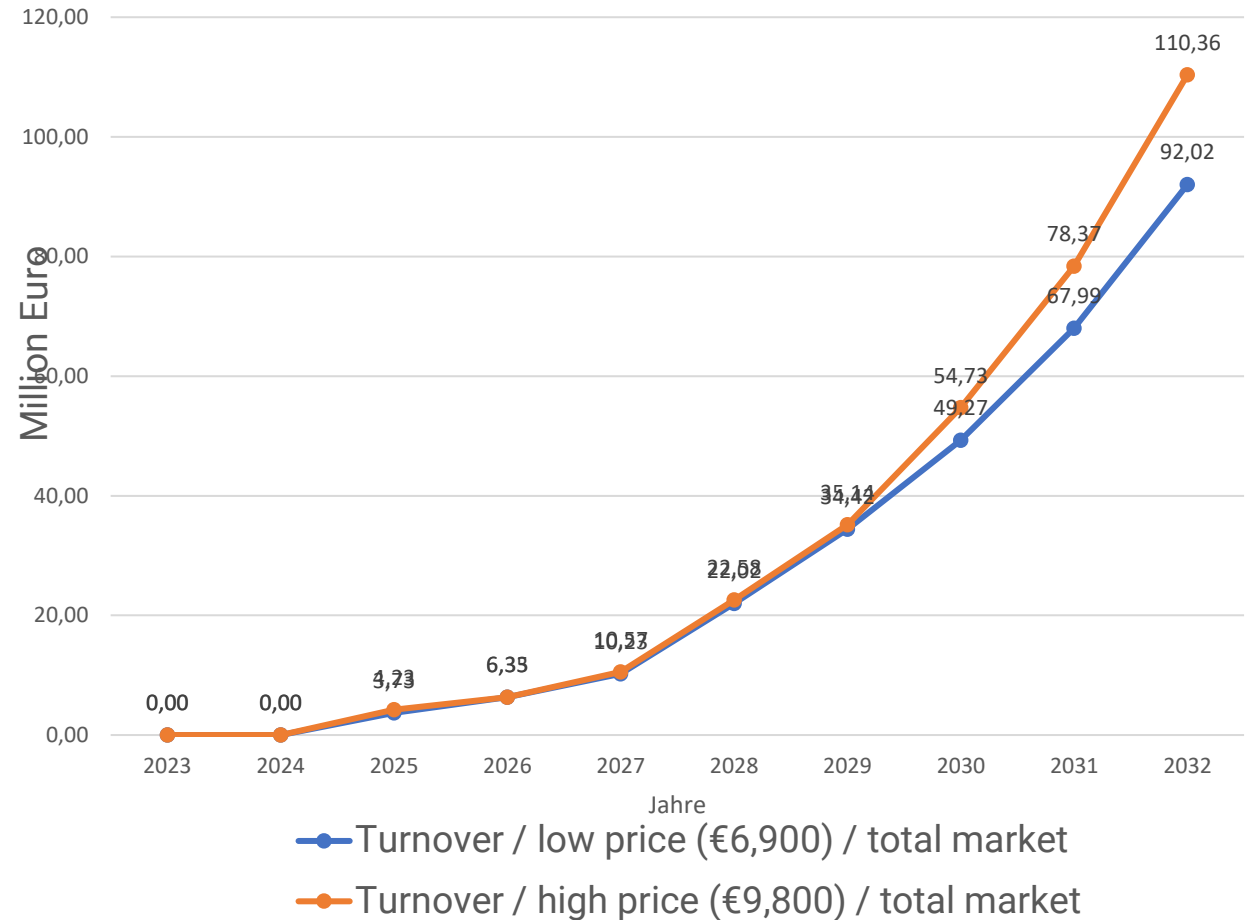

# EXAMPLE CALCULATION: PROFIT BEFORE TAXES IN MILLION € - EU, USA, ASIA, WITHOUT AFRICA

Calculation basis:

- Production costs/piece = €2,000
- Transport costs (overseas) = €100
- Sales / piece = 40% of the sales price
- License fees = 2.5% of sales
- Market growth = 10.4% per year
- Share of FFP thawing devices = 40%

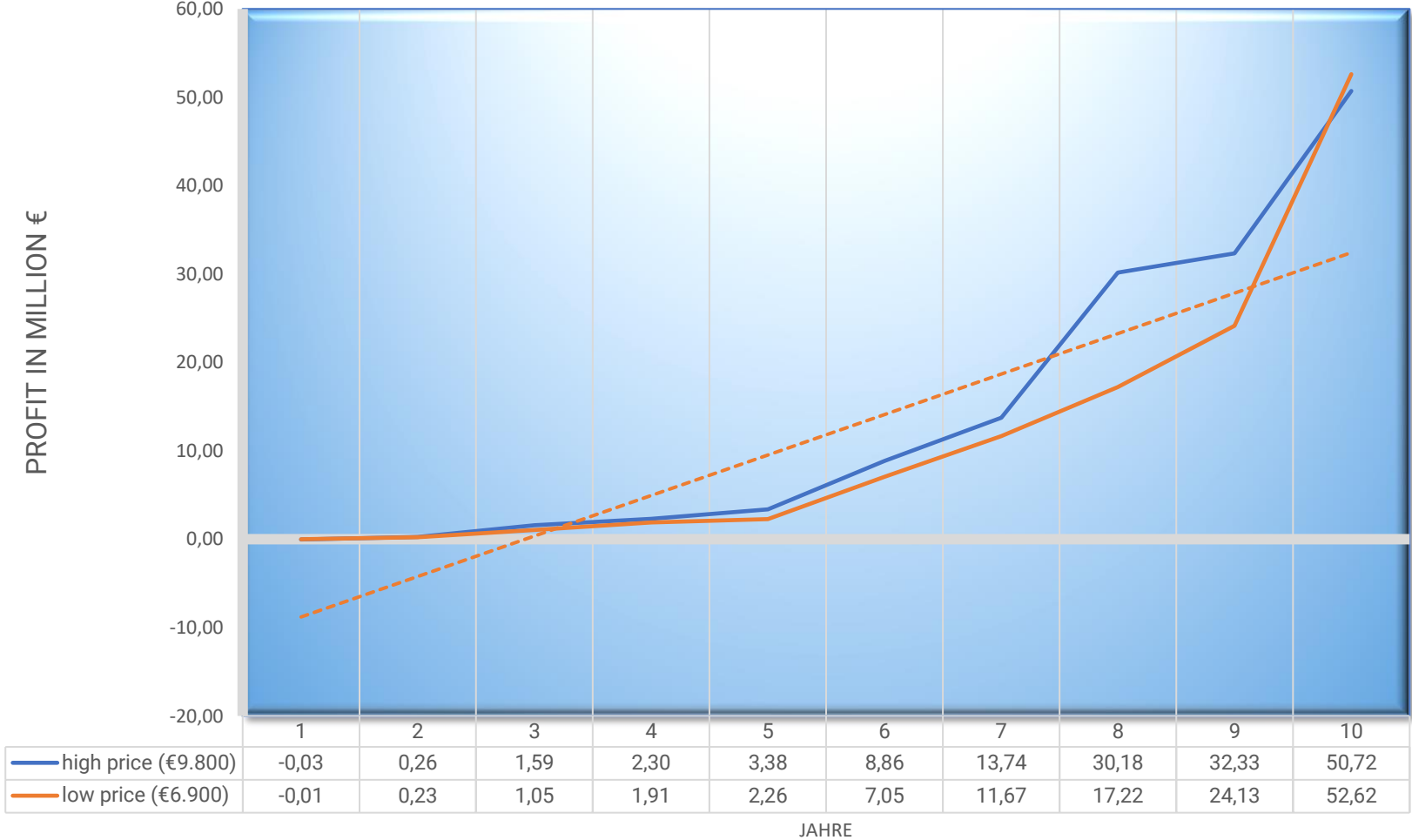

# THE ACTING PEOPLE

Prof. Dr.  
Wilfried Leven,  
Leven GmbH



Günther Schmidt,  
Inventor

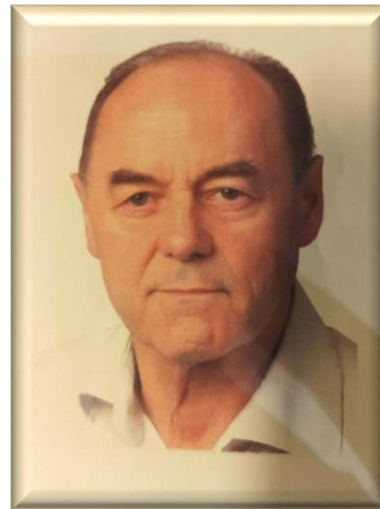

## WHY INVEST?

- ✓ PLASMA-THAWING-MACHINE IS UNIQUE
- ✓ SUPERIOR TECHNOLOGY
- ✓ PATENT AND UTILITY MODEL PROTECTION
- ✓ SECURE SALES MARKETS
- ✓ TRANSFUSION LAW PROTECTS
- ✓ HEALTH MARKET IS GROWING
- ✓ COMPETITION MANAGEABLE (< 15)
- ✓ RETURN EXPECTATIONS EXTREMELY HIGH
- ✓ PLASMA Q-DEFROST SAVES LIVES
- ✓ PLASMA-THAWING-MACHINE REDUCES HOSPITAL COSTS





**Success  
Ahead**

Leven GmbH  
Frankenstraße 29  
50858 Cologne, Germany  
+49 172 7115206  
wleven@blutplasma-auftauen.de  
Prof. Dr. Wilfried Leven